



### ***MC5300 and MC5600 Controllers***

Bard Manufacturing's MC Series of controllers offer easy setup and operation of WALL-MOUNT air conditioning, heat pump, and dehumidification products. The MC5300 controller allows for control of up to 3 units and the MC5600 controller allows for control of up to 6 units. Special features including filter alarm, emergency ventilation, and generator alarm. Alarming, remote monitoring, and Modbus control give the technician piece of mind that units are operating efficiently and the air is conditioned inside the building.



**CONFORMS TO UL STD 916**  
**CERTIFIED TO CSA STD C22.2 NO. 205**



**BARDHVAC.COM**

FORM NO. S3612-1120

**Climate Control Solutions**

## ENGINEERED FEATURES - EXTERIOR

The exterior of the MC controller is an industrial grade NEMA 1 enclosure. An ANSI 61 gray polyester paint design eliminates sharp edges on the door and inside the controller. 16 GA. steel construction with various knockout sizes. Cleanable vinyl graphics are present on the hinged front cover.



### Color Touchscreen

The controller includes a large 3.25" x 6" touchscreen with backlit display. An intuitive menu system provides settings and alarms.

### Quarter Turn Fastener:

Access to the inner control area is provided through a hinged door held closed with a quarter turn fastener.



### Multiple Knockouts:

Knockouts are provided for wire routing to units and for external communication and alarm wiring.

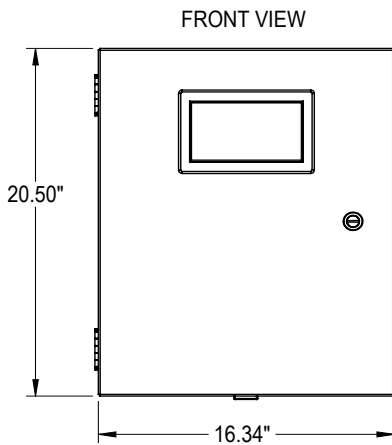
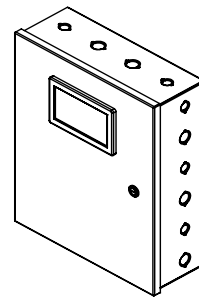
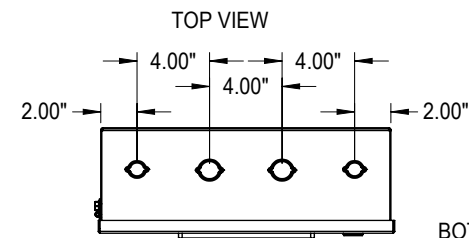

BOTH SIDES OF CONTROL BOX HAVE SAME DIMENSIONS FOR KNOCKOUTS

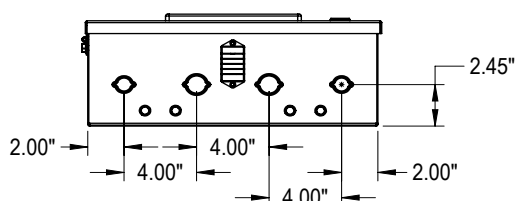
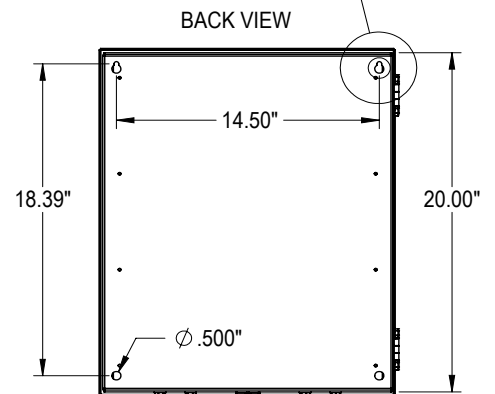
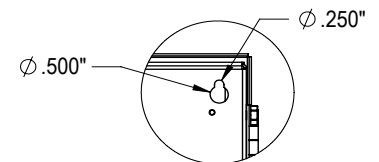
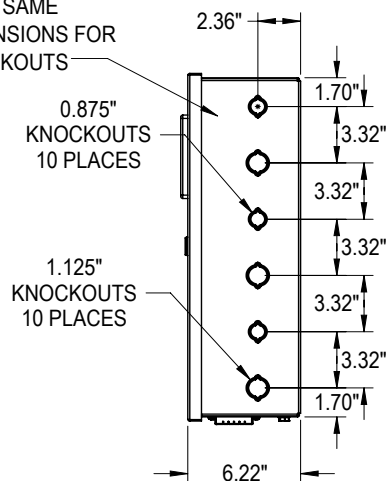

### CONTROLLER ENCLOSURE SPECIFICATIONS:

- 16-GAUGE POST-PAINTED GALVANIZED
- 20.50" H X 16.34" W X 6.22" D
- KNOCKOUTS
  - 10 TOTAL 7/8" KNOCKOUTS
  - 10 TOTAL 1-1/8" KNOCKOUTS

### NOTES:

GROUND LUGS ARE LOCATED ON THE INSIDE OF THE ENCLOSURE; DIMENSIONS FOR KNOCKOUTS ARE THE SAME ON LEFT AND RIGHT SIDES OF ENCLOSURE; TOP & BOTTOM KNOCKOUTS ARE SAME DISTANCE FROM BACK OF ENCLOSURE.

MIS-4187

## ////// MODEL FEATURE COMPARISON

MODELS	MC5300-C	MC5300-BC	MC5600-C	MC5600-BC
Number of Wall Mount Units	1 to 3	1 to 3	1 to 6	1 to 6
Lead/Lag	Yes	Yes	Yes	Yes
Cooling Stages	1 to 6	1 to 6	1 to 12	1 to 12
Compressor Heating Stages	1 to 6	1 to 6	1 to 12	1 to 12
Electric Heat Stages	1 to 6	1 to 6	1 to 12	1 to 12
Twinning	Yes	Yes	Yes	Yes
Hot Gas Reheat Dehumidification Stages	1 to 3	1 to 3	1 to 6	1 to 6
Synchronized Unit Dehumidification	Yes	Yes	Yes	Yes
Humidification Stages	1 to 3	1 to 3	1 to 6	1 to 6
<b>Electrical Specifications</b>				
Power Source	Unit 24VAC transformer	Unit 24VAC transformer	Unit 24VAC transformer	Unit 24VAC transformer
AC Voltage Range	18VAC to 32VAC 50/60hz	18VAC to 32VAC 50/60hz	18VAC to 32VAC 50/60hz	18VAC to 32VAC 50/60hz
Power Consumption	.265A @ 18VAC (min) and .963A @ 32VAC (max)	.294A @ 18VAC (min) and 1.19A @ 32 VAC (max)	.283A @ 18VAC (min) and 1.61A @ 32VAC (max)	.310A @ 18VAC (min) and 1.90A @ 32VAC (max)
Relay Output Ratings	.5A @ 150VDC 1A @ 30VDC/125VAC	.5A @ 150VDC 1A @ 30VDC/125VAC	.5A @ 150VDC 1A @ 30VDC/125VAC	.5A @ 150VDC 1A @ 30VDC/125VAC
<b>Remote Communication</b>				
Ethernet Communication - Modbus TCP/IP	Yes	Yes	Yes	Yes
Ethernet Communication - Webpages	Yes	Yes	Yes	Yes
<b>Alarms</b>				
Unit Power Loss Alarm	Local Only	Local and NO/NC Contacts	Local Only	Local and NO/NC Contacts
Unit Refrigerant Hi/Low Pressure Lockout	Local Only	Local and NO/NC Contacts	Local Only	Local and NO/NC Contacts
Smoke/Fire Alarm	Local Only	Local and NO/NC Contacts	Local Only	Local and NO/NC Contacts
Low Temperature Alarm	Local Only	Local and NO/NC Contacts	Local Only	Local and NO/NC Contacts
High Temperature #1 Alarm	Local Only	Local and NO/NC Contacts	Local Only	Local and NO/NC Contacts
High Temperature #2 Alarm	Local Only	Local and NO/NC Contacts	Local Only	Local and NO/NC Contacts
Filter Replacement Alarm	Local Only	Local and NO/NC Contacts	Local Only	Local and NO/NC Contacts
Anti-Theft Alarm	Local Only	Local and NO/NC Contacts	Local Only	Local and NO/NC Contacts
Vent Alarm	Local Only	Local and NO/NC Contacts	Local Only	Local and NO/NC Contacts
<b>Sensors</b>				
Temperature and Humidity Sensor	Yes	Yes	Yes	Yes
Number of optional remote sensors	Up to 2 (10K NTC)	Up to 2	Up to 2	Up to 2
<b>Controller Display and Software</b>				
Update Method	MicroSD Card	MicroSD Card	MicroSD Card	MicroSD Card
Communication Port	CAT 6	CAT 6	CAT 6	CAT 6
Interface	3.2"x 6" Touch Screen	3.2"x 6" Touch Screen	3.2"x 6" Touch Screen	3.2"x 6" Touch Screen
Comfort Mode	Yes	Yes	Yes	Yes
Twinning	Yes	Yes	Yes	Yes
Synchronized Dehum.	Yes	Yes	Yes	Yes
Test Mode	Yes	Yes	Yes	Yes
Continuous Blower	Yes	Yes	Yes	Yes
Emergency Off	Yes	Yes	Yes	Yes
Min. Run Time	Yes	Yes	Yes	Yes
Date/Time	Yes	Yes	Yes	Yes
Languages (English, Spanish, French)	Yes	Yes	Yes	Yes
Imperial or Metric Measurements	Yes	Yes	Yes	Yes

## ENGINEERED FEATURES - INTERIOR

The interior of the MC controller provides many features for use, installation and setup. Field wire connection screw terminals are identified and correspond to documentation inside the controller. Power is supplied to the controller by the wall mount units. Ethernet CAT 6 connection is provided for user remote interaction with the MC controller using built-in webpages or Modbus.

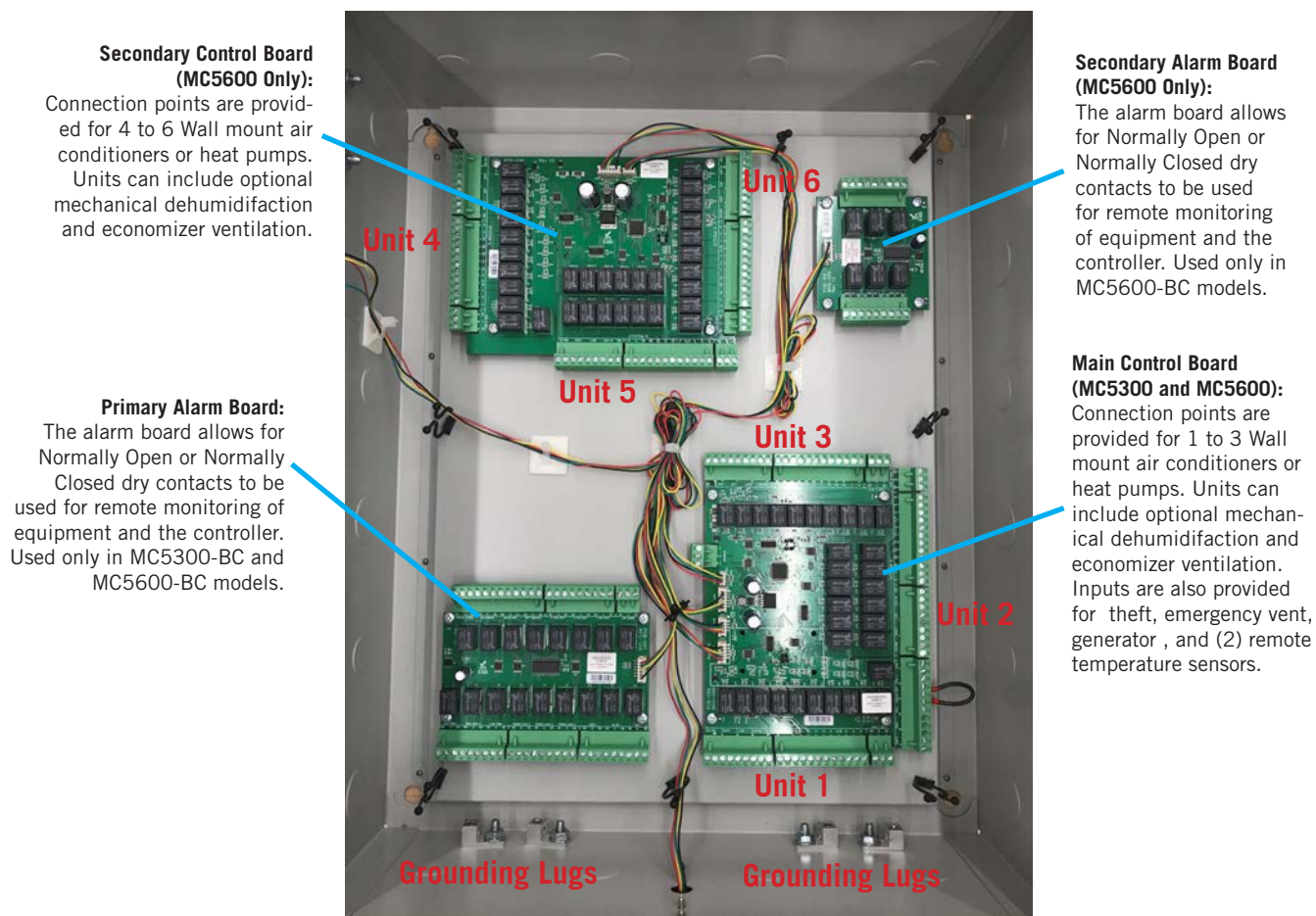

### Secondary Control Board (MC5600 Only):

Connection points are provided for 4 to 6 Wall mount air conditioners or heat pumps. Units can include optional mechanical dehumidification and economizer ventilation.

### Secondary Alarm Board (MC5600 Only):

The alarm board allows for Normally Open or Normally Closed dry contacts to be used for remote monitoring of equipment and the controller. Used only in MC5600-BC models.

### Primary Alarm Board:

The alarm board allows for Normally Open or Normally Closed dry contacts to be used for remote monitoring of equipment and the controller. Used only in MC5300-BC and MC5600-BC models.

### Main Control Board (MC5300 and MC5600):

Connection points are provided for 1 to 3 Wall mount air conditioners or heat pumps. Units can include optional mechanical dehumidification and economizer ventilation. Inputs are also provided for theft, emergency vent, generator, and (2) remote temperature sensors.

### Ethernet Cable Connection:

An ethernet CAT 6 port is provided to connect to built-in webpages or communicate via Modbus.

### SD Card Slot:

An SD card slot is provided for data storage, software updates, and backup.

### Post Painted 16ga. Steel Cabinet:

The controller enclosure is post painted 16ga. steel construction. Front door uses a 1/4 turn fastener latch.

### Emergency Off Jumper:

Remove jumper and connect to device for emergency equipment shutdown feature.

### Temperature and Humidity Sensor:

An onboard temperature and humidity sensor is provided with the controller. Two additional temperature sensors can be connected for remote temperature monitoring.

///// ENGINEERED FEATURES - CONTROL BOARDS

Main Control Board (MC5300 and MC5600)

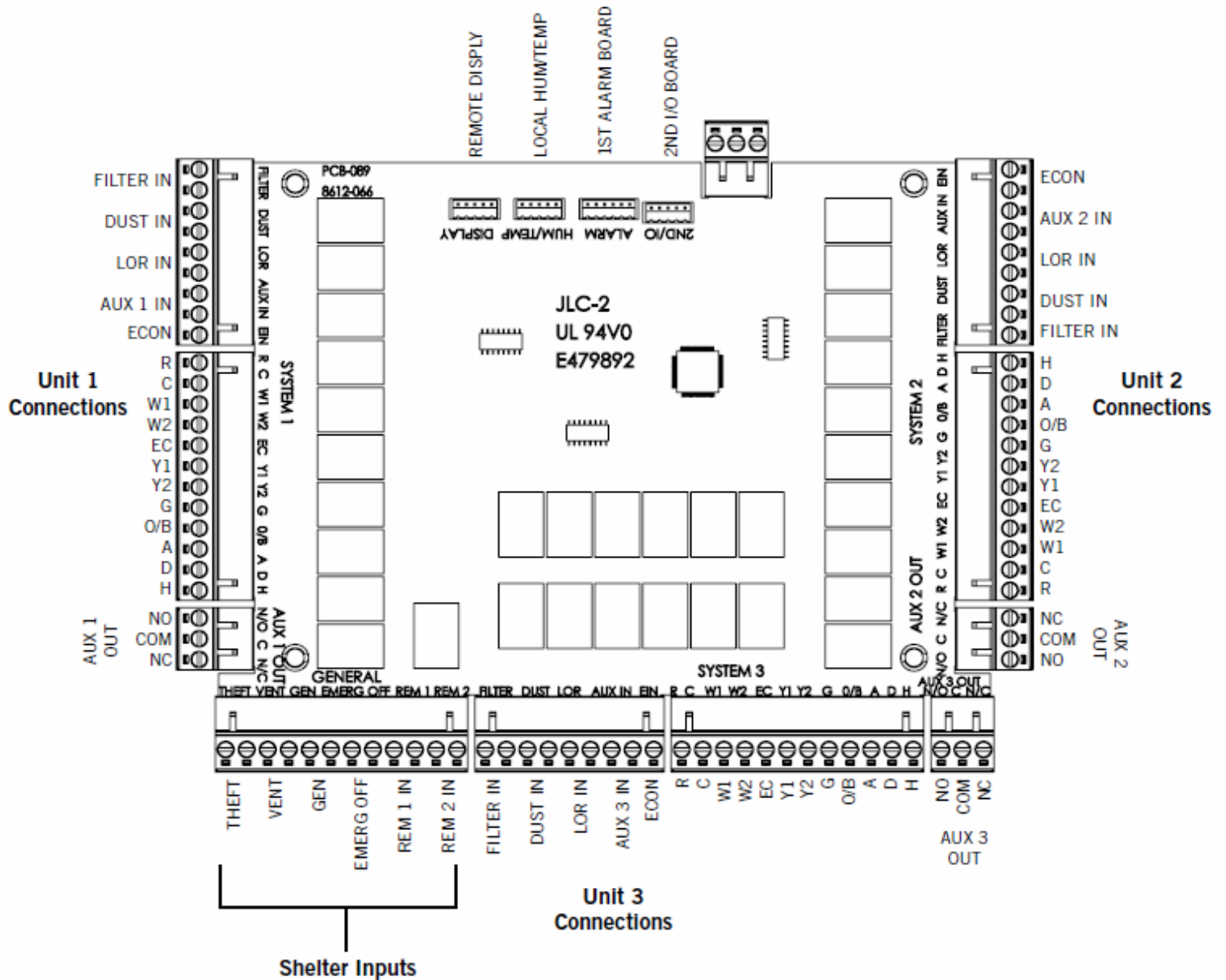

///// ENGINEERED FEATURES - CONTROL BOARDS

Secondary Control Board (MC5600 only)

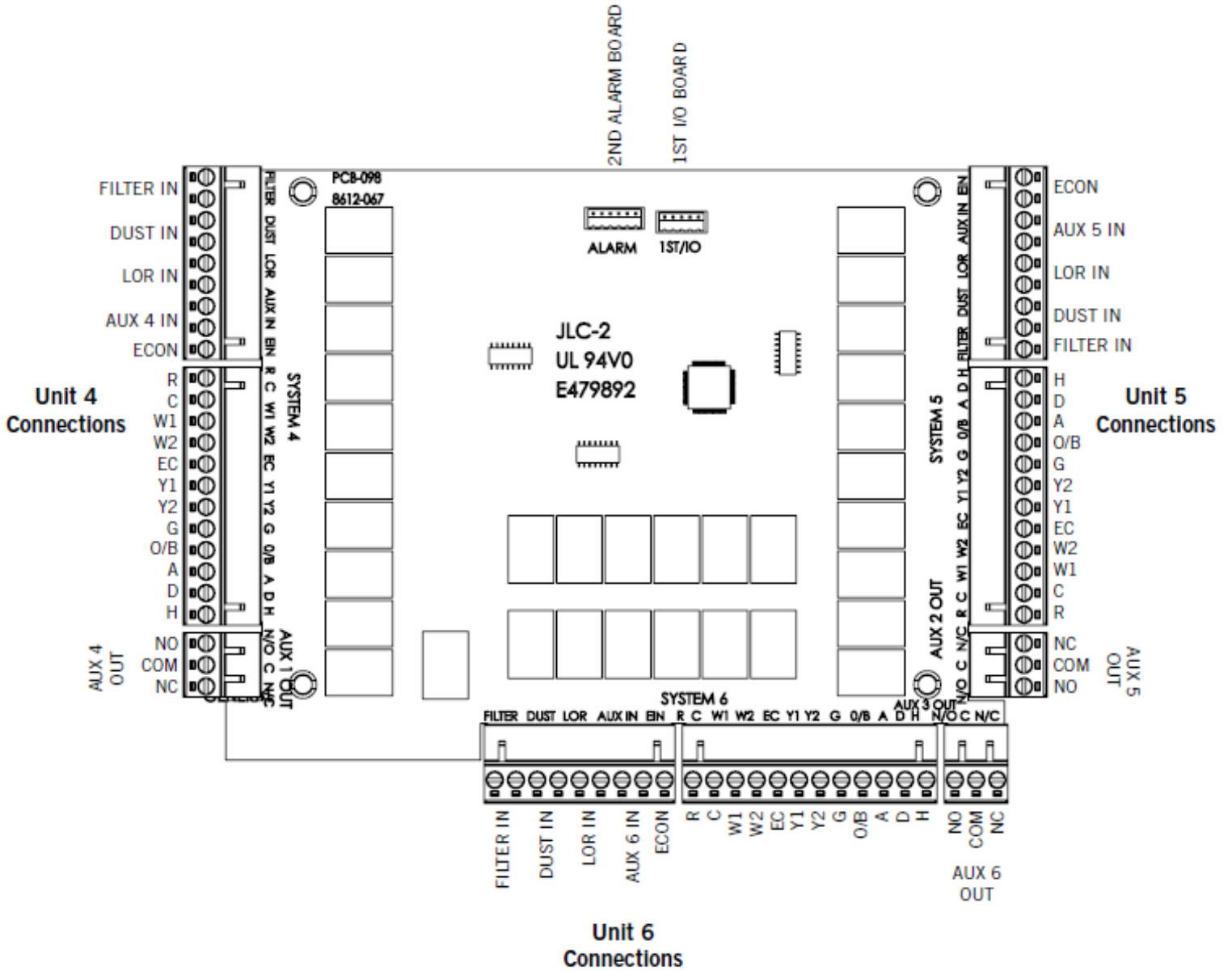

////// ENGINEERED FEATURES - OPTIONAL ALARM BOARDS

Main Alarm Board (MC5300-BC and MC5600-BC)

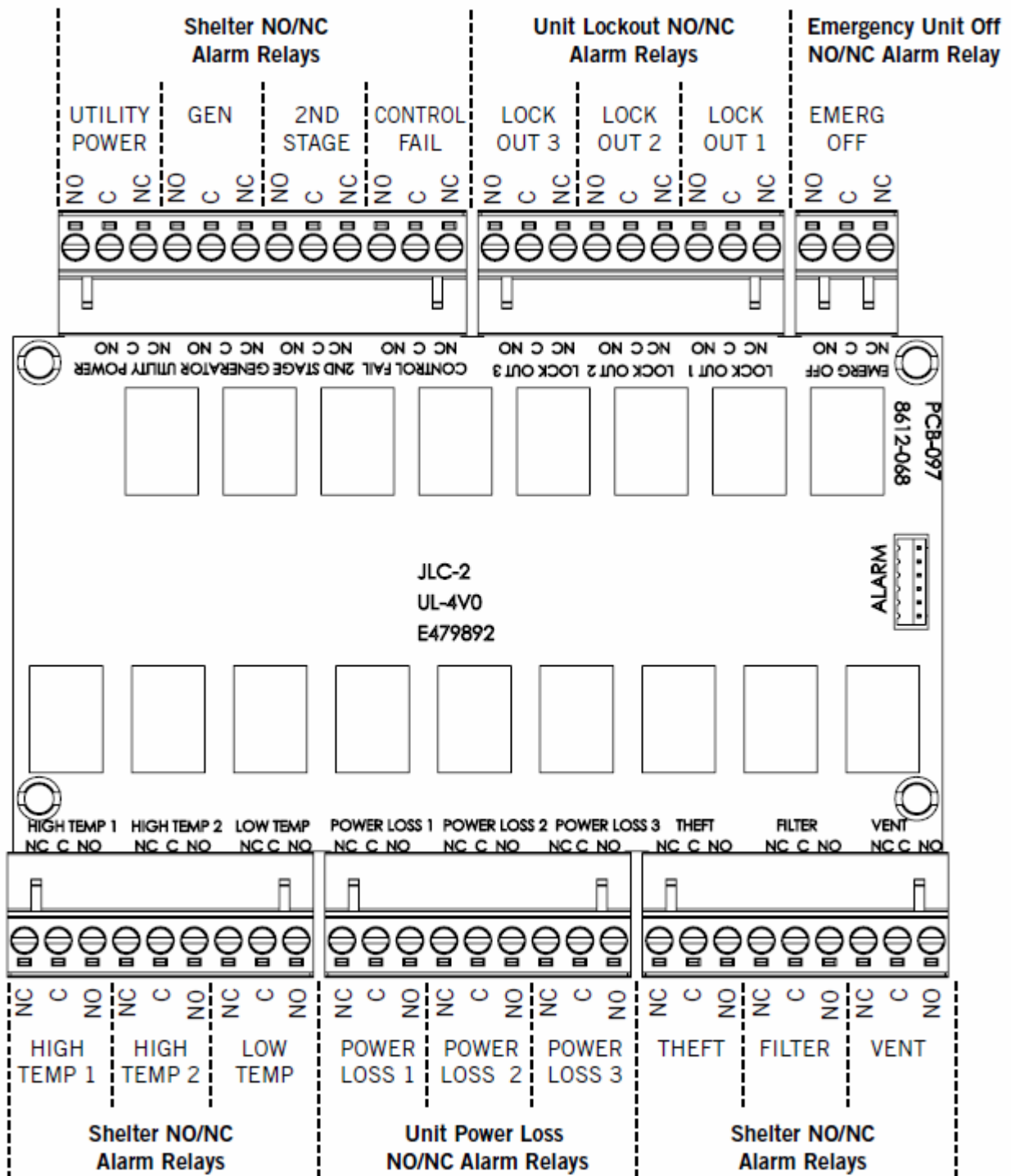

////// **ENGINEERED FEATURES - OPTIONAL ALARM BOARDS**

Secondary Alarm Board (MC5600-BC only)

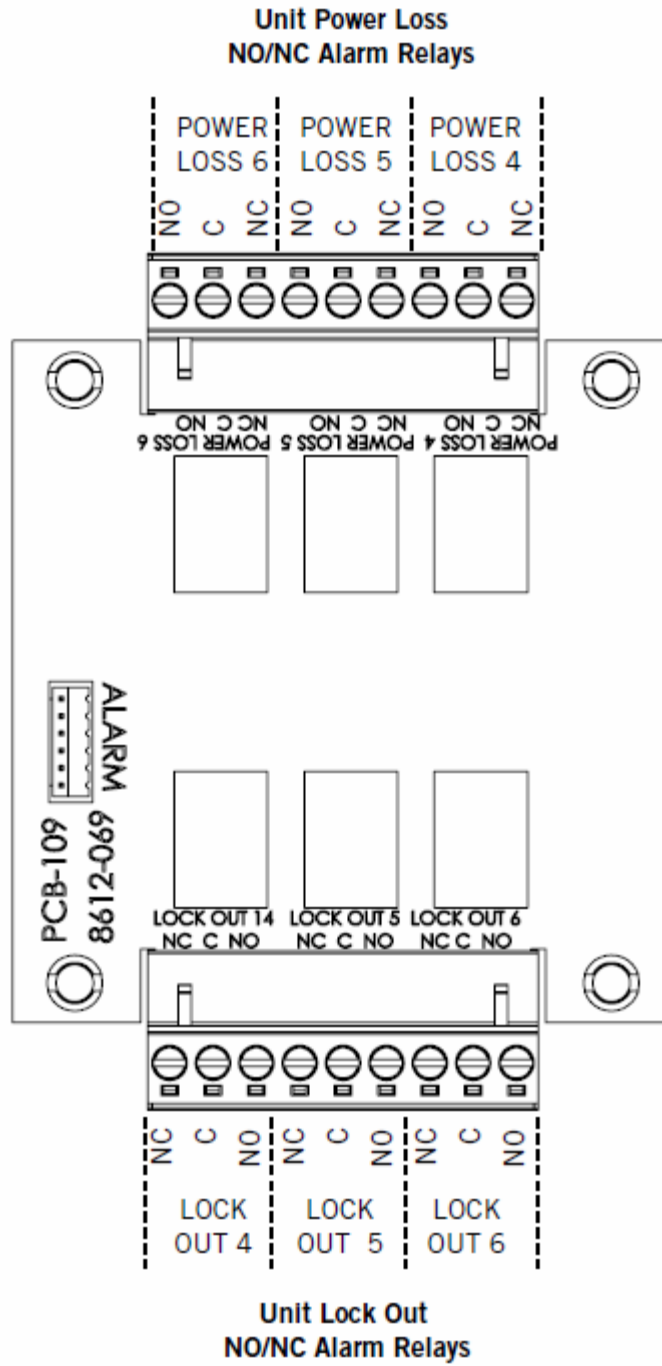



## ///// CONTROLLER NOMENCLATURE

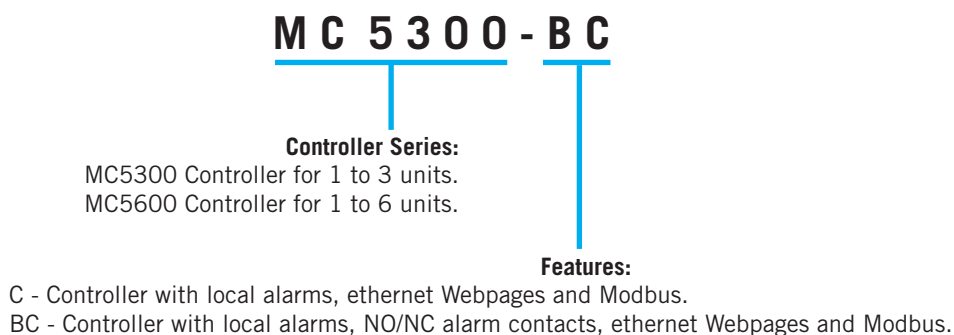

## ///// CONTROLLER OPTIONAL FEATURES

All MC5000 Series controllers have ethernet connectivity, and local monitoring and diagnostics through the use of the color touchscreen. The alarm board that will provide NO/NC contacts is available as an option. This can be used to connect to a building Network Operations Center (NOC) system using Normally Open and Normally Closed dry contacts.

### Features of the C and BC options:

**C** - Settings and alarms are available using the color touchscreen on the front of the controller. Remote monitoring can be accomplished through the ethernet connection provided using built-in webpages and a web browser, or by using Modbus and polling information from a points list.

**BC** - Settings and alarms are available using the color touchscreen on the front of the controller. Remote monitoring can be accomplished through the ethernet connection provided using built-in webpages and a web browser, or by using Modbus and polling information from a points list. One alarm board for Normally Open/Normally closed contacts for 1 to 3 units is provided with the MC5300-BC controller. Two alarm boards for Normally Open/Normally closed contacts for 1 to 6 units are provided with the MC5600-BC controller.

NO/NC Output Contacts for each unit: Hi/Lo Pressure Unit Lockout, Power Loss.

NO/NC Output Contacts for all units: Theft, Dirty Filter, 2nd cooling stage.

NO/NC Output Contacts for Controller: Controller fail, Generator, Utility Power Loss, Hi Temp 1, Hi Temp 2, Hydrogen\*, Smoke/Fire\*.

\*Note: It is the responsibility of the installer to ensure all code and application requirements are met for hydrogen and smoke/fire systems. Review all information in the controller and unit installation instructions regarding controller and unit operation.

## ///// SOFTWARE NOMENCLATURE

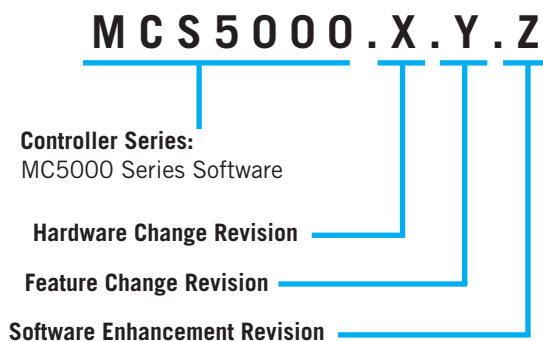

## ///// SOFTWARE UPDATES

### Software Use:

The MC Series controllers contain an solid state logic board with on-board software similar to a computer. Software updates, as they become available, will be posted to the following address: [www.bardhvac.com/software-download/](http://www.bardhvac.com/software-download/). Program changes may require the use of an ethernet cable and/or a MicroSD card. Additional ethernet cables and MicroSD card readers can be found at most stores carrying cell phones and electronics equipment.

## ////// MC CONTROLLER UNIT CONNECTIVITY FEATURES

### Compatible Units:

**WA Series** Single Stage AC Wall Mounts: The MC5300 can control 1 to 3 WA Series Air Conditioning Units and the MC5600 can control 1 to 6 Units. The units can have 1 or 2 stage electric heat, dehumidification and economizer options installed. CRV and ERV ventilation options can be used, but need to be energized during blower operation.

**WSAC Series** Two Stage AC Wall Mounts: The MC5300 can control 1 to 3 WSAC Series Air Conditioning Units and the MC5600 can control 1 to 6 Units. The units can have 1 or 2 stage electric heat, dehumidification and economizer options installed. CRV and ERV ventilation options can be used, but need to be energized during blower operation.

**WH Series** Single Stage HP Wall Mounts: The MC5300 can control 1 to 3 WH Series Heat Pump Units and the MC5600 can control 1 to 6 Units. The units can have 1 or 2 stage electric heat, dehumidification and economizer options installed. CRV and ERV ventilation options can be used, but need to be energized during blower operation.

**TS and CH Series** Two Stage HP Wall Mounts: The MC5300 can control 1 to 3 TS and CH Series Heat Pump Units and the MC5600 can control 1 to 6 Units. The units can have 1 or 2 stage electric heat, dehumidification and economizer options installed. CRV and ERV ventilation options can be used, but need to be energized during blower operation.

### MC5000 Series Unit 24VAC Output Connections:

*R, C:* Each unit supplies 24VAC to the MC5000 controller.  
*EC:* Economizer stage of cooling.  
*Y1, Y2:* 2 compressor cooling and heating stages.  
*G:* Indoor blower operation.  
*W1, W2:* 2 stage electric heat output.  
*O/B:* Reversing valve operation for heat pump models.  
*A:* Ventilation output.  
*E:* Future use.  
*D:* Dehumidification output.  
*H:* Humidifier output.  
*Aux. Out:* Configurable Output.

### MC5000 Series Unit 24VAC Input Connections:

*LOR:* Low/Hi Pressure Lock Out Relay is Active. Unit must include a Lockout Relay Controls Option. See unit specifications for feature availability.  
*DUST:* Dust sensor is disabling economizer operation. Unit must include a dust sensor controls option. See unit specifications for feature availability.  
*FILTER:* Dirty Filter Indicator is active. Unit must include a dirty filter controls option. See unit specifications for feature availability.  
*AUX IN:* Future use.

### Alarm Board Contacts

#### Alarm Board 1 Outputs

- UTILITY POWER (Relay Output NO, NC)
- GENERATOR (Relay Output NO, NC)
- 2ND STAGE (Relay Output NO, NC)
- CONTROL FAIL (Relay Output NO, NC)
- LOCK OUT 3 (Relay Output NO, NC)
- LOCK OUT 2 (Relay Output NO, NC)
- LOCK OUT 1 (Relay Output NO, NC)
- EMERG OFF (Relay Output NO, NC)
- HIGH TEMP 1 (Relay Output NO, NC)
- HIGH TEMP 2 (Relay Output NO, NC)
- LOW TEMP (Relay Output NO, NC)
- POWER LOSS 1 (Relay Output NO, NC)
- POWER LOSS 2 (Relay Output NO, NC)
- POWER LOSS 3 (Relay Output NO, NC)
- THEFT (Relay Output NO, NC)
- FILTER (Relay Output NO, NC)
- VENT (Relay Output NO, NC)

#### Alarm Board 2 Outputs

- POWER LOSS 6 (Relay Output NO, NC)
- POWER LOSS 5 (Relay Output NO, NC)
- POWER LOSS 4 (Relay Output NO, NC)
- LOCK OUT 4 (Relay Output NO, NC)
- LOCK OUT 5 (Relay Output NO, NC)
- LOCK OUT 6 (Relay Output NO, NC)

## ////// MC CONTROLLER DISPLAY INFORMATION AND SETTINGS

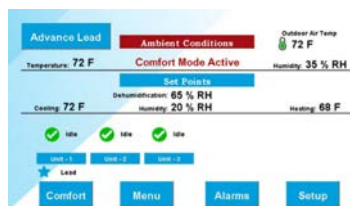

### Main Display:

The main controller display shows the status of all systems connected to the controller, ambient conditions inside the area being conditioned, and temperature and humidity setpoints. System status indicates the total amount of units connected, if they are in cooling or heating mode, and identifies the lead unit. Ambient conditions including indoor temperature and humidity are displayed. Outdoor temperature is displayed if an field supplied outdoor sensor is used. Set points includes heating and cooling setpoints, and a dehumidification setpoint for units installed with the ability to run in dehumidification mode. Touchscreen buttons are provided for comfort mode, the settings menu, active and past alarms, and a setup wizard.

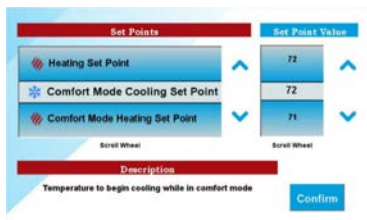

### Comfort Mode:

When comfort mode is selected from the main display, the heating and cooling setpoint will be temporarily set to the values provided in the setpoint menu. The unit will continue to run in comfort mode for 60 minutes. After the 60 minute period, the temperature heating and cooling setpoints will default back to the normal setting.



### Main Menu:

The main menu allows access to System Status, Equipment Status, Set Points, Test Mode, and Restore Defaults functions.

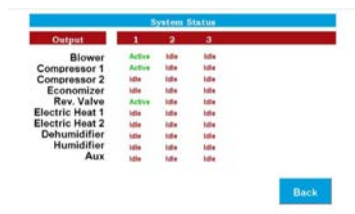

### System Status:

The system status menu will display the output signals being given by the MC controller to all units. Active will indicate that the signal for that function is being sent to the unit identified in the numbered unit column. Idle will indicate that no signal for the specific command is being sent by the MC controller. Outputs include Blower, Compressor stages 1 and 2, Economizer, Reversing Valve, Electric Heat stages 1 and 2, Dehumidification, Humidification, and Auxiliary.

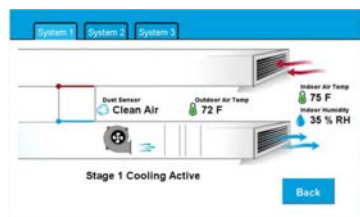

### Equipment Status:

The equipment status menu will display the output signals being given by the MC controller to each unit. A visual indicator will show unit outputs provided to each unit. individual units can be selected using the tabs at the top of the screen. Outputs include Blower, Compressor stages 1 and 2, Economizer, Reversing Valve, Electric Heat stages 1 and 2, Dehumidification, Humidification, and Auxiliary.

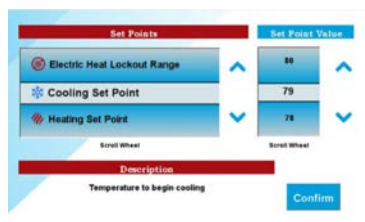

### Set Points:

The Set Points menu allows for adjustment of multiple settings used by the MC controller. The following settings are available in the setpoints menu:

- Cooling Set Point (Default 79°F)
- Heating Set Point (Default 60°F)
- Comfort Mode Cooling (Default 72°F)
- Comfort Mode Heating (Default 78°F)
- Dehumidification Set Point (Default 65%RH)
- Humidification Set Point (Default 20%RH)
- Cooling Interstage Differential (Default 2°F)
- Heating Interstage Differential (Default 2°F)
- Dehumidification Interstage Differential (Default 2%RH)
- Humidification Interstage Differential (Default 1%RH)
- Low Temperature Alarm (Default 45°F)
- High Temperature Alarm Level 1(Default 90°F)
- High Temperature Alarm Level 2(Default 95°F)
- Heat Pump Lockout (Default None)
- Electric Heat Lockout (Default None)

## ////// MC CONTROLLER AND UNIT TEST MODE

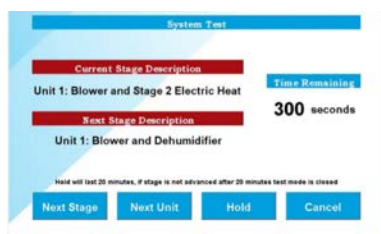

### Unit Test Mode:

Unit test mode allows the technician to energize each stage of operation and verify unit connectivity and functionality. The following operations can be verified using test mode:

- Blower operation
- Cooling operation and staging
- Heating operation and staging
- Economizer operation
- Dehumidification operation
- Humidification operation

## ////// MC CONTROLLER SETUP MENU



### Setup:

The setup menu offers the user the ability to make changes to the software settings based on the units connected to the controller. It also offers several options based on user preference. Menu options are as follows;

- System Setup
- Equipment Setup
- Date/Time Setup
- Output Control
- IP Configuration
- Save User Defaults



### System Setup:

The System Setup menu offers the user the ability to make changes to the software settings based on the units connected to the controller. It also offers several options based on user preference. Menu options are as follows;

- **Language Selection:** English (Default), Spanish, French Options.
- **Password Protection:** The user may want to lock out all access to controller functionality unless they know a user password. Setup and setpoint features can be locked out using a pin number that is user defined.
- **Staging Logic:** Staging logic adjustment allows the user to select how units cool in economizer and compressor cooling stages. Alternating staging (Default) can be selected to advance the stage of each unit as needed to condition the area. Non-Alternating staging can be used to stage the lead unit through all available stages to condition the area before operating the next unit.
- **Lead/Lag Changeover Time:** Lead/Lag allows for equal run time for equipment to lengthen component life. 0 to 30 (Default 7) days can be selected to adjust the timing of lead unit advancement. A setting of 0 will not allow for lead/lag changeover.
- **Continuous Blower:** Based on building design and internal area heat load, constant continuous airflow may be desired in the room. The Continuous blower feature allows the user to select the blower to run continuously in the lead unit, all units, custom, pre-purge, or none (Default) of the units. Custom allows the user to select continuous blower for each unit. Pre-purge allows for all units to run blower operation for a pre-determined time before cooling begins. Pre-purge time can be set for 1 to 5 minutes.
- **Pre-Purge:** This feature allows the user to circulate the air in the space to be conditioned to combat stratification and allow for a more accurate measurement of space conditions before activating the initial call for cooling or heating. Circulation time will be selectable by user (1 to 5 minutes in one minute increments). If selected, pre-purge will be functional on initial call for cooling, heating, dehumidification and humidification operation. **Pre-purge will run all available blowers for the user selected time.**
- **High Humidity Economizer Disable:** This feature allows the user to disable the economizer when dehumidification operation is required. By disabling the economizer when high indoor humidity is present, the area being conditioned will no longer be affected by outdoor air humidity levels due to free cooling economizer operation.
- **Degrees:** The user can select between Fahrenheit and Celsius as the unit of measure used by the controller.
- **Temperature Sensor Logic:** (2) additional temperature sensors can be added to the controller for a total of (3) temperature and (1) humidity sensor. If multiple temperature sensors are used, the user can select the units to begin cooling based on an average of all sensors (Default), the highest sensor reading, or the lowest sensor reading.
- **Twinning:** Twinning allows for reduced staging when operating multiple units. Two, three, or all units may be operated as a single stage. Options are pairs, triples, all units, or off. This feature allows the user to reach full capacity with reduced staging.

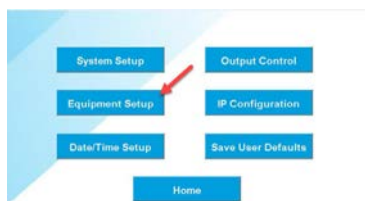

**Unit Setup:**

The setup menu offers the user the ability to identify the equipment that is being connected to the controller. Menu options are as follows;

- Number of HVAC Systems:** This setting allows the user to select how many air conditioner or heat pump units are connected to the controller. The MC5300 controller is capable of controlling from 1 to 3 units (Default is 3). The MC5600 is capable of controlling 1 to 6 units (Default is 6). By selecting the number of units connected to the controller, the proper visuals will appear on the main screen, and unit staging will be properly preformed.
- Number of Compressor Stages:** This setting allows the user to select how many compressor cooling stages are available in the air conditioning or heat pump unit. Current selections are 1 or 2 (Default) stages. The following cooling compressor stages are available for product models: WA Series 1 stage, WH Series 1 stage, WAS Series 2 stages, TH Series 1 stage, TS series 2 Stages, CH Series 2 stages. Connecting multiple product types with different stages is not recommended due to delays in staging. If units connected to the controller have a different number of stages, use the highest number of stages available in the units.
- Number of Heat Pump Stages:** This setting allows the user to select how many electric heat stages are available in the air conditioner or heat pump unit. Air conditioning only units use 0 to specify the product does not include electric heat. Current selections are 0, 1 or 2 (Default) stages. Products with up to 6kw electric heat normally only have 1 electric heat stage. Refer to the user manual or unit wiring diagram for available heating stages. Connecting units with different electric heater stages is not recommended due to delays in staging. If units connected to the controller have a different number of stages, use the highest number of stages available in the units.
- Maximum Number of Units While in Generator Mode:** This setting allows the user to select how many units can run while a generator active alarm is present. If the generator will not supply enough power to operate all units connected to the controller, this feature can be used to limit unit usage while the generator active alarm is present. The user can select from 1 to 3 units or All units to be active during a generator event.
- Dehumidifier Type:** By using dehumidification and proper unit setup, humidity levels in the area being conditioned can be reduced. Unit Cycling for dehumidification does not require the unit to be equipped with dedicated dehumidification options, but does require electric heat use and at least (2) air conditioning or heat pump units. When in synchronized mode, (1) unit will operate in compressor cooling mode and (1) unit will run in electric heating mode to maintain room temperatures while removing moisture from the air. If indoor conditions require heating or cooling to maintain indoor conditions, the units will cycle between normal and dehumidification operation. This method of removing moisture is the least effective and least efficient due to the constant cycling of heating or cooling and dehumidification. Mechanical dehumidification requires the purchase of air conditioning or heat pump units equipped with the mechanical reheat circuit (a D is present as the fifth digit of the unit model number). Mechanical dehumidification will use a reheat coil in the supply airstream that is heated by refrigerant. The reheat coil warms the supply air after the air conditioning process cools the air to remove moisture. Multiple units with this feature can be used in stages for additional humidity control. This method of removing moisture is the most effective and most efficient due to the use of the reheat circuit. Dehumidification setpoints are accessed in the setpoint menu.
- Humidifier Present:** By using an optional humidifier and proper unit setup, humidity levels in the area being conditioned can be increased. By indicating that a humidifier is present, the controller will energize the H terminal for each unit based on the humidity setpoint. Staging is based on the timed response speed and/or the area humidity variation from the humidifier setpoint in the setpoint menu.
- REM 1 Temperature Sensor:** An additional temperature sensor may be connected to the REM1 terminal on the main controller board. When used, the additional sensor will provide the capability of temperature averaging in the area being conditioned. It will also provide an additional backup temperature sensor connected to the controller to monitor indoor conditions. Select indoor temperature if this feature is used.
- REM 2 Temperature Sensor:** An additional temperature sensor may be connected to the REM2 terminal on the main controller board. When used, the additional sensor will provide the capability of temperature averaging in the area being conditioned. It will also provide an additional backup temperature sensor connected to the controller to monitor indoor conditions. Select indoor temperature if this feature is used. The REM2 terminal can also be used to monitor outdoor temperature. By monitoring outdoor temperature, conditions can be set for heat pump operation to limit compressor heating and electric heat use based on outdoor conditions. Connection of an outdoor sensor will also allow for monitoring remotely outdoor temperature.
- Dust Sensor:** A dust sensor may be connected to the controller for each unit used. By monitoring dust content in the air being brought into a room using an economizer, the damper can be disabled when levels are unacceptable. The Dust In input on the main control board is dry contacts. The dust sensor is currently a field supplied and installed option only.

## ////// DATE/TIME SETUP



### Date/Time Setup:

The controller can use the date and time to log unit alarms, schedule lead/lag rotation, and use other time based features in the controller. Hour - Minute - AM/PM and Month - Day - Year formats are used. Time and date is stored in the battery backup of the controller.

## ////// TEST MODE



### Test Mode:

This feature allows the user or service technician to manually energize 24VAC terminals used by the controller. Each unit is identified by tabs at the top of the screen. Energizing the terminals allows for wire and unit troubleshooting without manually adjusting sensor readings or adjusting unit operational parameters. Terminals stay energized for up to 500 seconds.

## ////// IP CONFIGURATION



### IP Configuration:

Ethernet settings can be adjusted to connect to the controller and view built-in webpages. Modbus TCP/IP is also available.

## ////// ETHERNET WEBPAGES

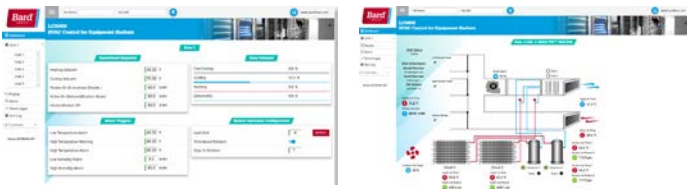

### Ethernet Webpages:

Using an internet browser and the ethernet cable connection, the user or technician can remotely monitor equipment status, adjust setpoints, monitor room conditions, and view alarms.

## //////// MC5300 AND MC5600 CONTROLLER ACCESSORIES



The MC5300 and MC5600 controller includes an onboard temperature and humidity sensor. Additional parts can be ordered as service items, and service tools are also available. The following list is provided for reference and ordering information.



PART NO.	PART NAME	DESCRIPTION
8301-095	Temperature Sensor	Up to (2) additional temperature sensors can be used with the MC series controller. The sensors are 10k type 2 temperature monitoring devices. Cable length is 35 ft.
8408-061	Temp/Humidity Sensor	The on board temperature and humidity sensor may be replaced with a remote mounted sensor. Cable length is 35 ft.

## //////// MC5300 AND MC5600 FIELD SUPPLIED WIRING

24VAC UNIT TO CONTROLLER WIRING	DESCRIPTION
Wire Size	18GA Recommended, 22GA minimum*
Wire Conductors	Dependent on unit features

\* Bard recommends shielded cable where electromagnetic interference may be present.

## //////// MC5300/MC5600 CONTROLLER AND UNIT CONNECTION DIAGRAM

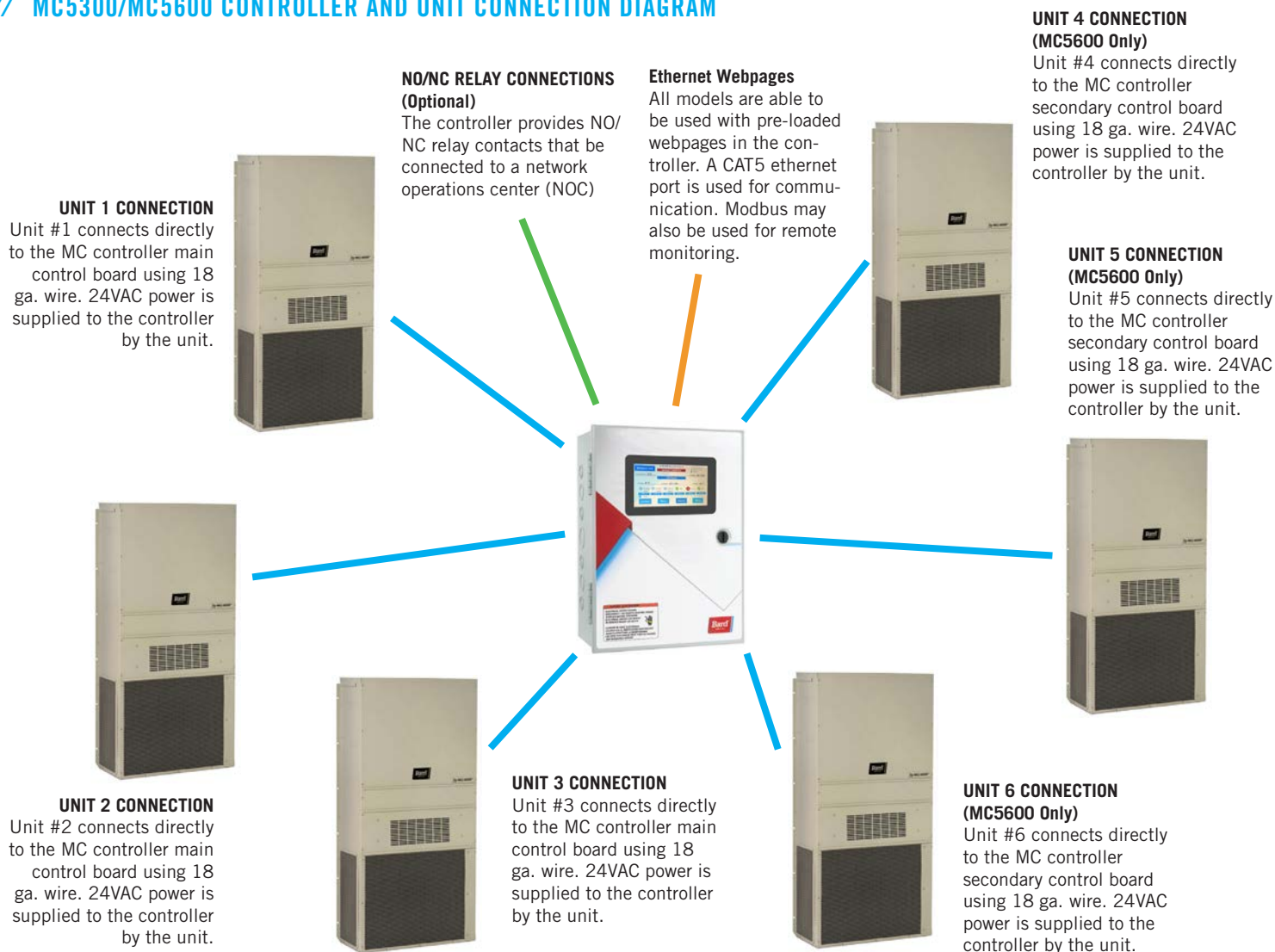

## Standard MC Controller Commissioning and Job Planning Sheet

Job Site:	Building Number:
Job Address:	
Contractor:	Technician:
Customer:	Contact Info:
Date Comissioned:	Comissioned By:
Controller Model and Serial #:	
Unit 1 Model and Serial #:	
Unit 2 Model and Serial #:	
Unit 3 Model and Serial #:	
Unit 4 Model and Serial #:	
Unit 5 Model and Serial #:	
Unit 6 Model and Serial #:	

Setup Information	Choices	Default	Job Setup
Number of HVAC Systems (units):	1 to 6	1	
Number of compressr stages for each unit:	1 or 2	1	
Are the units Heat Pumps?	Yes or No	No	
Energize O/B during cooling or heating?	Cooling or Heating	Heating	
Number of electric heat stages:	0, 1, or 2	1	
Dehumidifier Type:	None, Synchronized, or Mechanical	None	
Number of Dehumidifier Units:	0 to 6	0	
Humidifier Present:	Yes or No	No	
Auxiliary Output Configuration for single alarm:	Em. Off, Gen Run, Hi Humidity, Dust, or Dehum Active	Emergency Off	
Language:	English, French, or Spanish	English	
Password:	Yes or No	No	
Twinning Logic Staging:	Off, All, or Paris	Off	
Staging Logic:	Alternating/Non-Alternating	Alternating	
Lead/Lag Changeover time (days):	0-30	7	
Continuous Blower Logic:	Lead, None, All, Prepurge, or Custom	None	
Degrees:	Fahrenheit or Celsius	Fahrenheit	
Temp Sensor Logic:	Average, Highest, or Lowest	Average	
Rem 1 temperature sensor:	Indoor temp or Not connected	Not Connected	
Rem 2 temperature sensor:	Indoor temp, Outdoor temp or Not connected	Not Connected	
Equipment minimum run time (mins):	0-5	3	
Maximum Number of units in Generator Mode:	1-6	1	
Touch screen display brightness (%):	10-100	80	

Controls Equipment Testing	Yes	No
Unit High Voltage connected/Tested?		
24VAC unit transformer 208/240V tap correct?		
Reviewed all 24VAC wiring to MC from units?		
Test cooling/heating/vent unit #1 complete?		
Test cooling/heating/vent unit #2 complete?		
Test cooling/heating/vent unit #3 complete?		
Test cooling/heating/vent unit #4 complete?		
Test cooling/heating/vent unit #5 complete?		
Test cooling/heating/vent unit #6 complete?		
Emergency Off System Tested?		
Emergency Ventilation System Tested?		
Remote Wired Alarming Tested?		
Ethernet/Modbus Connection Tested?		



////// MC CONTROLLER NOTES:



Bard Manufacturing Company, Inc.  
1914 Randolph Dr., Bryan, OH 43506  
419-636-1194

[www.bardhvac.com](http://www.bardhvac.com)

**Due to our continuous product improvement policy,  
all specifications subject to change without notice.**